

# Analysis Proton Conducting Electrolyte IT-SOFC Hybrid System Exhaust Gas With External Reforming of Biofuel

Nizar Amir<sup>1,2</sup> and I.N.G. Wardana<sup>2</sup>

<sup>1</sup>Department of Mechanical Engineering, National Central University, Chungli 320, Taiwan

<sup>2</sup>Department of Mechanical Engineering, Brawijaya University, Malang, Indonesia

E-mail: nizaramr@gmail.com

Received 3 February 2013; First revised 23 May 2013, Second revised 29 May 2013; Accepted 29 May 2013;

Published online 4 June 2013 for edition May-August 2013

## ABSTRACT

In this analysis, a hybrid system containing proton conducting electrolyte solid oxide fuel cell (P-SOFC) combined with micro gas turbine (MGT) with biofuel external reforming is investigated to decrease the greenhouse gases problem in electrical power plant. The hybrid system consists of a P-SOFC stack, a MGT, a combustor, compressors, heat exchangers and external reformer. The main operating parameter such as, fuel utilization and steam-to-carbon ratio are determined in this analysis.

Key word: proton SOFC, hybrid system, external reforming, greenhouse gases

## INTRODUCTION

Many studies assume that the result of the increasing in greenhouse gas (GHG) concentrations into the atmosphere causes increase global temperatures in the world, i.e. global warming. The greenhouse explanation is based on the increasing in the global mean temperature simultaneously which is caused by the increasing in emissions of carbon dioxide and other GHG in the atmosphere. Methane is one of the GHG. There have been many efforts to substitute it into the renewable energy sources. Many fuels have been suggested to be used in solid oxide fuel cell (SOFC). Methanol is considered to be a favorable renewable fuel because it can be produced from renewable energy sources and also able to produce high hydrogen gas in low reforming temperature process [1-2]. This can be implied that the methanol external reforming can operate with proton conducting electrolyte solid oxide fuel cell (P-SOFC) at intermediate temperature.

Fuel cell is considered to be the best promising green technology for direct chemical to electrical energy conversion. SOFC have very attractive characteristics as they offer many potential applications, such as combined with micro gas turbine (MGT). SOFC-MGT hybrid system is one of the most interesting options for distributed power generation, due to its high efficiency and low pollutant emission. High temperature SOFC operates in the temperature range of 900 - 1000 °C. They have very high efficiency when they are combined with gas turbines for large-scale power plant system, but high temperature SOFC hybrid system requires expensive materials. To reduce material cost in smaller scale applications, there is a trend to change to lower operation temperatures, the so-called intermediate temperature (IT) range of 500-750 °C [3].

Efficiency P-SOFC is higher than oxide conducting electrolyte solid oxide fuel cell (O-SOFC) because high H<sub>2</sub> partial pressure at the anode side can be achieved due to water that is produced at the cathode side resulting in an improved open circuit voltage and

enhanced efficiency of the P-SOFC. The problem in P-SOFC with internal steam reforming of methane provides high GHG (25 mol. %) [4]. Therefore, to decrease this problem, external steam reforming P-SOFC hybrid system fueled by methanol is investigated. The P-SOFC hybrid system is simulated by using MATLAB-Thermolib software.

## MODELLING

### Proton conducting SOFC

A planar P-SOFC consists of a Ni-BCSO as anode, BCSF-BCSO as electrolyte and BCSO as cathode (Ni BCSO|BCSF-BCSO|BCSO). The values of parameters used in this work are as follows: the cell area of  $0.01 \text{ m}^2$ , cell number of 50, fuel utilization of 0.83, heat transfer coefficient of  $5 \text{ W/K}$ , initial temperature  $323 \text{ K}$  and stack pressure of 2 bar.

The electrochemical reactions in the P-SOFC are:

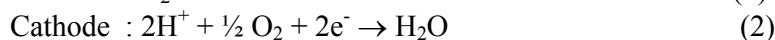

In the P-SOFC,  $\text{H}_2$  is fed to anode fuel channel and  $\text{H}_2$  is oxidized to  $\text{H}^+$  and  $\text{e}^-$ . Protons are transported through the electrolyte to the cathode compartment and react with  $\text{O}_2$  to form  $\text{H}_2\text{O}$  in cathode side. The electrons flow through an electrical load and produce electricity. The advantages from this reaction are  $\text{H}_2\text{O}$  produced in cathode side and no dilution of hydrogen gas by  $\text{H}_2\text{O}$ , enabling high electromotive force. The electromotive force ( $V_{EMF}$ ) for this reaction at temperature  $T$  can be calculated as follows [5]

$$V_{EMF} = \frac{RT}{2F} \ln \frac{K p\text{H}_2 (p\text{O}_2)^{0.5}}{p\text{H}_2\text{O}} \quad (3)$$

where  $p\text{H}_2$ ,  $p\text{O}_2$  and  $p\text{H}_2\text{O}$  are hydrogen, oxygen and water partial pressure, respectively.  $R$  is universal gas constant,  $T$  is the absolute temperature and  $F$  is Faraday's constant. In practice, there are losses (ohmic loss, activation loss, concentration loss) causing deviation between  $V_{EMF}$  and actual cell voltage ( $V_c$ ). The actual cell voltage is determined as follows:

$$V_c = V_{EMF} - \Delta V_{\text{losses}} \quad (4)$$

where  $\Delta V_{\text{losses}}$  is sum of the losses. In this investigation, only ohmic and activation losses are considered in calculation. The concentration losses can be ignored because in this investigation it is assumed that fuels and oxidants are well diffused. The power generated by P-SOFC stack can be evaluated from:

$$P_{\text{SOFC}} = I V_c A \quad (5)$$

where  $I$  is current density that can be defined as the transfer rate of ionic charge per unit effective fuel cell area.  $V_c$  is the actual cell voltage, and  $A$  is effective fuel cell area. The electrical efficiency is defined as the ratio of electrical power produced by SOFC ( $P_{P\text{-SOFC}}$ ) to the chemical energy in fuel represented by lower heating value of fuel ( $LHV_f$ ) multiplied by mass flow rate of fuel ( $m_f$ ) as shown in the following equation:

$$\eta_{\text{SOFC}} = \frac{P_{P\text{-SOFC}}}{m_f LHV_f} \quad (6)$$

### Hybrid System

The methanol reforming process has been described by means of the following reaction [6]:

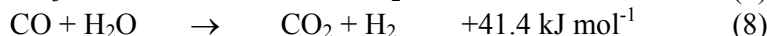
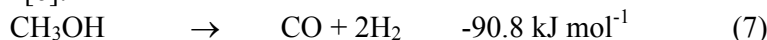

According to the above reforming reaction, the well mixed of 1 mole of methanol requires 1 mole of water. Too small steam-to-carbon ratio (S/C) are to be avoided as they can lead to carbon formation, whereas too high S/C lead to hydrogen dilution [7]. Compressor and MGT of hybrid system also play important roles in determining the overall performance of the system. In this investigation, all components are assumed working at their respective designed conditions under steady state operation. The system efficiency is determined as follow:

$$\eta_{\text{System}} = \frac{P_{P\text{-SOFC}} + P_{\text{MGT}} - P_{\text{Comp}}}{m_f LHV_f} \quad (9)$$

where  $P_{\text{MGT}}$  and  $P_{\text{comp}}$  are net power produced by MGT and power consumed by compressor during process, respectively. Computation of the heat exchange between the hot and cold fluids in the heat exchanger, which are counter-flow heat exchangers, is based on the effectiveness-number of transfer units ( $\varepsilon$ -NTU) method. The values of parameters used in this work are as follows : S/C of 1, compressor efficiency of 78%, turbine efficiency of 83%, pressure ratio of 2, air flow rate of  $0.083 \text{ mol s}^{-1}$ , fuel flow rate of  $0.003 \text{ mol s}^{-1}$  and heat exchanger overall heat transfer of  $5 \text{ W/K}$

## RESULTS AND DISCUSSION

Figure 1 shows the schematic diagram of the P-SOFC hybrid power system considered in this work. The hybrid system employs a topping arrangement mode, and the P-SOFC stack is a substitute for combustion chamber of MGT. The planar P-SOFC with methanol as input fuel is selected. Compressed air and fuel are preheated at their respective heat exchanger prior to entering the P-SOFC stack. Methanol is externally reformed in the reformer and hydrogen rich products are generated. Hydrogen gas and oxygen flow through the anode and cathode compartments, respectively. The electrochemical reaction occurs in the P-SOFC compartment to produce electrical power output. The other electrical power is produced in MGT using waste heat from P-SOFC stack. The waste heat from MGT is partly used for steam reformer and heating air.

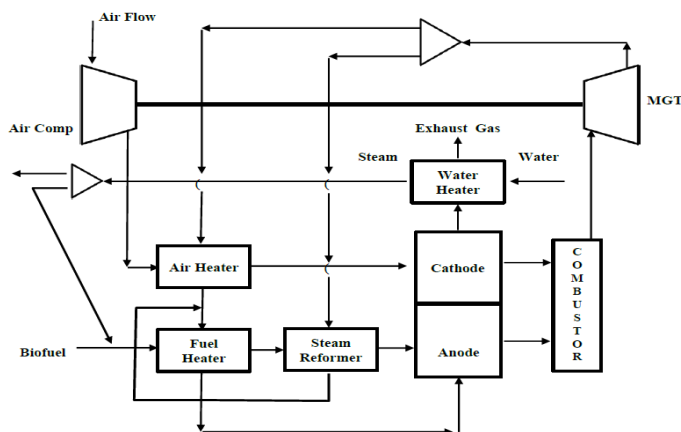

**Figure 1.** Schematic diagram of external reforming P-SOFC hybrid system

The effluent gases of the P-SOFC stack, including unreacted fuel and depleted air are channeled to a combustion chamber, where residual fuel (hydrogen, methanol and carbon

monoxide) reacts with the depleted air. The combustion product gas expands in the MGT to produce electrical output. And the last, the low temperature exhaust gas from fuel heater is used to cooling the stack and then heating water to increase the efficiency of system.

### Effect fuel utilization

Fuel utilization is an important parameter, which is related to the performance of P-SOFC and exhaust gas. The fuel utilization is defined as the ratio of amount of hydrogen consumed within the fuel cell, to the amount of hydrogen available in the fuel cell. The influence of fuel utilization on power P-SOFC, CO<sub>2</sub> and CO content on exhaust gases are shown in Fig 2, Fig 3 and Fig 4, respectively. As the fuel utilization increases from 0.80 to 0.90, the P-SOFC power increases from 609 W to 630 W, CO and CO<sub>2</sub> content on exhaust gas decreases from  $544 \times 10^{-6}$  to  $257 \times 10^{-6}$  and  $296 \times 10^{-4}$  to  $283 \times 10^{-4}$ , respectively. Electrochemical reaction increases thus raising the electrical power output produced by the P-SOFC and then P-SOFC works more efficient when fuel utilization increases causing decreasing of GHG contain in exhaust gas.

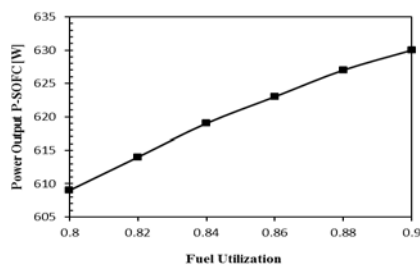

Figure 2. Effect fuel utilization on power output P-SOFC

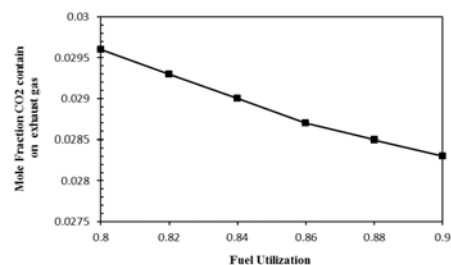

Figure 3. Effect fuel utilization on CO<sub>2</sub> content on exhaust gas

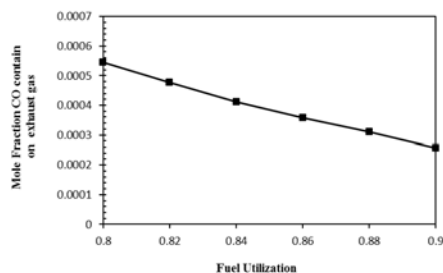

Figure 4. Effect fuel utilization on CO content on exhaust gas

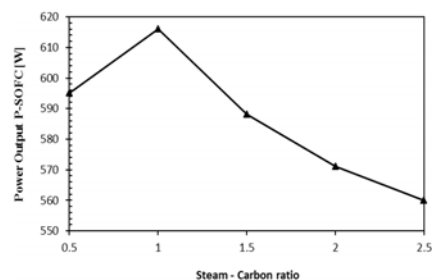

Figure 5. Effect steam-carbon ratio on power output P-SOFC

Use methanol external steam reformer decreases of GHG. Because with external steam reformer, hydrogen gas production can be achieved 96%. This is also the strongest effect on the decrease of GHG.

### Effect Steam Carbon - ratio

S/C of 0.5 is sufficient to reform the methanol, but more steam is usually used in order to prevent the formation of carbon. Figure 5 shows the effect of S/C on the power of P-SOFC. When S/C increases from 0.5 to 2.5, P-SOFC power output increases then decreases when S/C is further increased to 2.5. At the first, increase S/C can promote the water gas shift

reaction is associated with increase  $H_2$  gas production, then too high S/C leads to  $H_2$  dilution in the steam reforming process. It is the strongest effect of decreasing P-SOFC power output [8]. For example, P-SOFC power output increases from 595 W to 616 W and then decreases to 560 W. When more steam is added in the steam reformer, the CO formations can be reduced, because an addition of steam can increase water gas shift reaction, as shown in the Fig 6. However the  $CO_2$  concentration increases as a result of the increase water gas shift reaction but increasing of  $CO_2$  concentration is still lower enough for solution to decrease  $CO_2$  concentration in P-SOFC with methane internal steam reforming [4], as shown in the Fig 7.

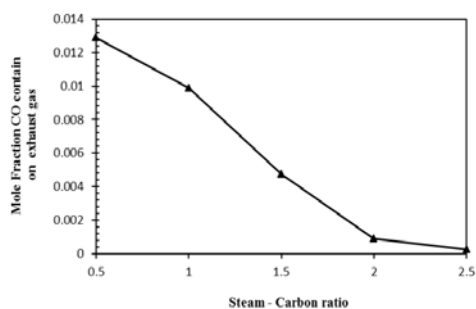

**Figure 6.** Effect steam-carbon ratio on CO content on exhaust gas

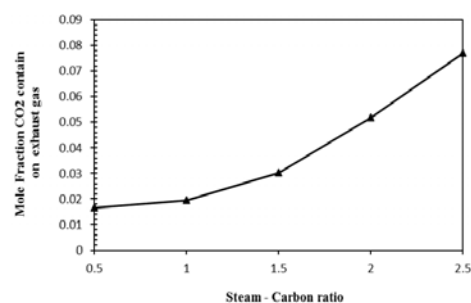

**Figure 7.** Effect steam-carbon ratio on  $CO_2$  content on exhaust gas

## CONCLUSION

In this analysis, P-SOFC hybrid system with external steam reforming of methanol was investigated. Methanol is very favourable fuel for P-SOFC hybrid system. The lower reforming temperature of methanol reasonable to locate the steam reformer outside the stack to increase the hydrogen gas concentration then enhances P-SOFC power output. In this analysis was found that increasing fuel utilization can increase P-SOFC power output and then GHG reduces. S/C is important parameter to enhance P-SOFC power output and decreases GHG. Increasing S/C will reduce the CO formation, but the  $CO_2$  concentration increases slightly due to increase water gas shift reaction. Stack power output increases and then decreases when S/C is further increased to 2.5. The hydrogen gas dilution is the strongest effect of decreasing stack power output when S/C is further increased to 2.5.

## REFERENCES

- [1] K. Faungnawakij, R. Kikuchi, K. Eguchi, *J. Power Sources*, **2006**, (161), 87-94
- [2] Y. Lwin, W. Daud, AB. Mohamad, Z. Yaakob, *Int J Hydrogen Energy*, **2000**, (25), 47-53
- [3] D. J. Brett, A. Atkinson, N. P. Brandon and S. J. Skinner, *Chem. Soc. Rev.*, **2008**, (37), 1568-1578
- [4] A. Arpornwichanop, Y. Patcharavorachot, and S. Assabumrungrat, *Chem. Eng Sci*, **2010**, (65), 581-589
- [5] A. K. Demin, Thermodynamic of the sofc based on the proton conductive electrolyte, *Dissertation*, Institute of High-Temperature Electrochemistry, RAS Ural Branch, Ekaterinburg, **2001**.
- [6] F. Joensen, J. R. Rostrup-Nielsen, *J. Power Sources*, **2001**, (105), 195-201
- [7] P. Tsiakaras, A. Demin, *J. Power Sources*, **2001**, (102), 210-217
- [8] D. Cocco, V. Tola, *Energy*, **2009**, (34), 2124-2130